

DR-1040x1040 P8

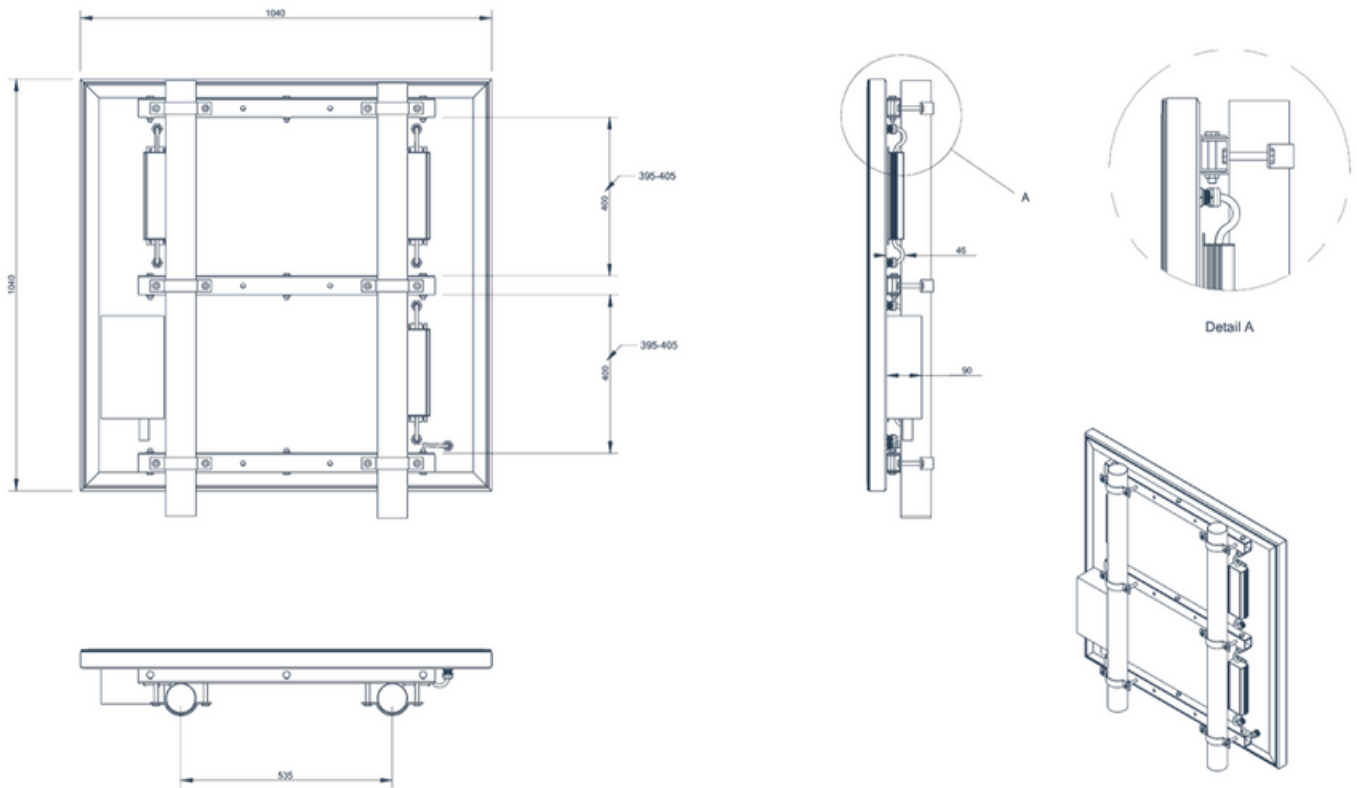

Pixel Pitch	P8
Dimensions (WxHxD)	1040x1040x50 mm
Min. Viewing distance	8 meters
Brightness	6500 nits
Input Voltage	240VAC
Power avg.	200 W
Weight	48 kg
IP Rating	IP 65
Certification	CE, RoHS

FEATURES

- Full color and full matrix high quality LED SMD arrays
- Anti-glare front glass for extra protection
- Supported media: text with various effects, png, moving gif
- Supports live video feed with additional video controller
- Verified high-end components
- Fanless design for extra durability

USAGE



CONTENT EXAMPLES



DR-1040x1040 P8

Pixel Pitch	P8
Resolution	120x120 pixels
Brightness	6500 nits
Viewing angle	H:140 V:120
Color	16 bit/color
Interface port	LAN CAT 5/5e/6
Operation	24/7
Operating Temperature	-35° C ... +50
Power Consumption max.	600 W
Serviceability	Front and back
Certification	CE, RoHS
Warranty	1 year



Rugged DR Series

DR-1040x1040 P8

AMPRON
WWW.AMPRON.EU